

WE ARE CLOSER THAN YOU THINK!

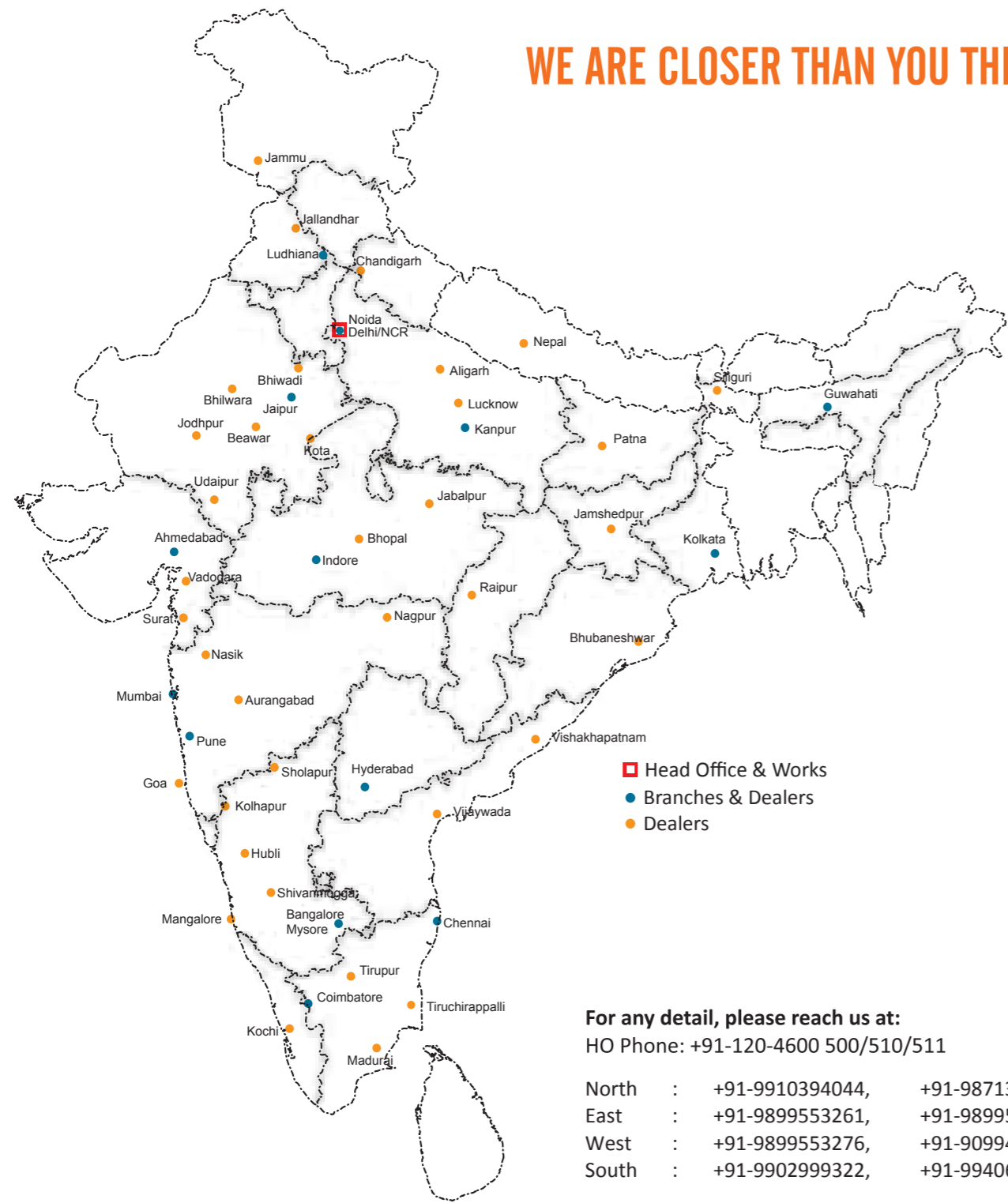

For any detail, please reach us at:
 HO Phone: +91-120-4600 500/510/511

North	:	+91-9910394044,	+91-9871362399
East	:	+91-9899553261,	+91-9899553270
West	:	+91-9899553276,	+91-9099472222
South	:	+91-9902999322,	+91-9940654560

More than 75 dealers across India



ANEST IWATA MOTHERSON PVT. LTD

B-123 & 124, Sector-63, Noida-201301, Distt. Gautam Budh Nagar, U.P., India
 Phone: +91 120 4600 500/510/511
 Email: anestiwata@aim.motherson.com

www.aimcompressors.com



the
FUTURE
 of **AIR**

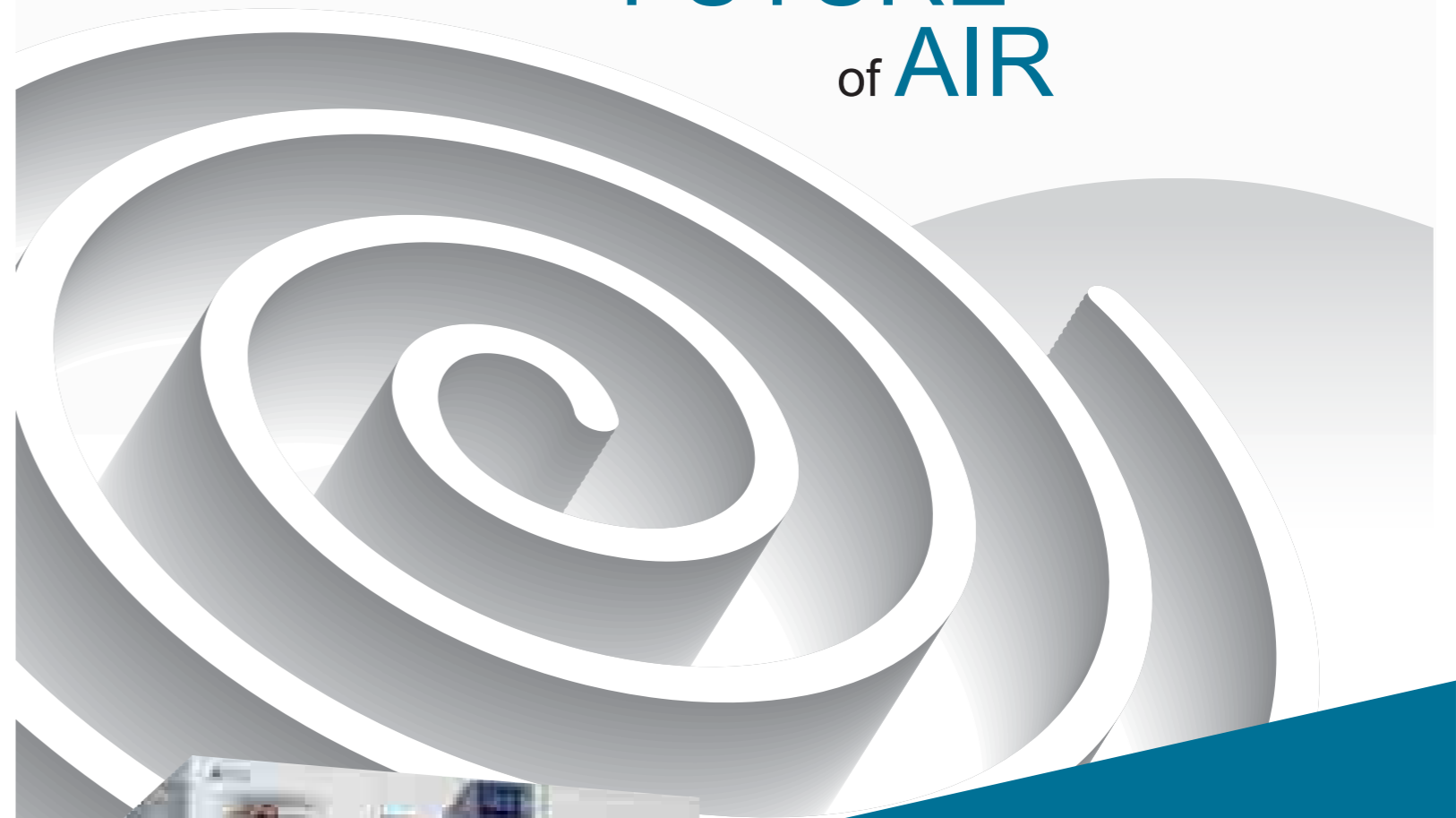

Oil Free Scroll Compressors
The Air of Trust



Proud to be part of samvardhana **motherson**

Oil Free Scroll Compressors are constantly evolving

ANEST IWATA was the first manufacturer to introduce Oil Free Scroll Compressors in 1991 and has kept improving them ever since in order to provide customers with the most advanced technology for high-quality air.



Scroll Compressors An Industrial Evolution

Representing the most efficient engineering principles in air compression, and with an eye on the future, Anest Iwata, Japan developed the world's first oil free scroll compressors for industrial air applications.

The same pioneering and world-class technology is available in India through Anest Iwata Motherson (AIM), a joint venture between Anest Iwata, Japan & Samvardhana Motherson Group, India.

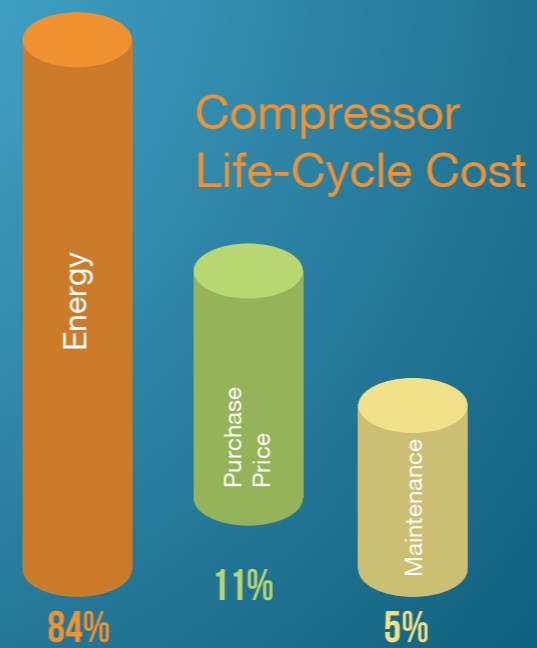

Evolutional History of Scroll Compressor



The Most Advanced Technologies for High-Quality Air

High-precision processing technology is required to produce the components that make up a Scroll Compressor.

We have developed new Scroll Air-Ends thanks to the experience and know-how we have accumulated over the past 20 years.



Scroll Compression Principle

As the orbiting scroll goes from No.1 to No.4 position, the size of the symmetrical crescent-shaped compression chambers is gradually reduced, compressing the air contained within. This is then discharged through the central exhaust port.

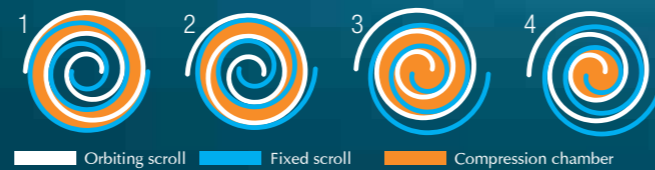

Oil-Free Drain

Drainage from oil-lubricated compressors requires proper treatment as it contains oil.

Oil-free scroll compressors, on the other hand, are eco-friendly, their drain is clean and does not contain oil, therefore avoiding the cost of drain disposal.

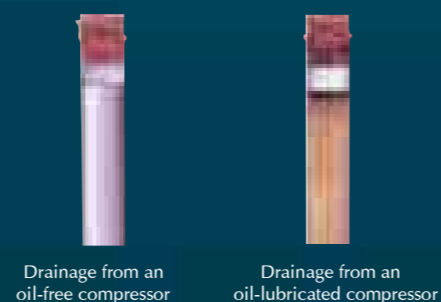

Clean

Air from oil-lubricated compressors contains oil and can contaminate the piping. This does not happen with an Oil-Free Scroll Compressor which produces high-quality oil-free air.

INSIDE THE PIPING OF AN OIL-LUBRICATED COMPRESSOR



INSIDE THE PIPING OF AN OIL-FREE COMPRESSOR



Class Zero Certification

TÜV (independent third party test house) has just certified that the air quality from our oil free scroll compressors is in conformity with "Class 0 (ISO8573-1:2010[-:-:0])".



What is Class Zero ?

ISO8573-1 (JIS B8392-1) defines quality classes for compressed air. Class Zero indicates wall flow oil, oil mist and oil vapor are completely absent. As oil vapor in particular cannot be absorbed by conventional air filters, it is important factories that require clean air use Class Zero compressors.

CLASS	Oil Concentration mg/m ³
0	As specified by the equipment user or supplier and more stringent the Class 1
1	≤ 0.01
2	≤ 0.1
3	≤ 1
4	≤ 5



① Wall Flow Oil ② Oil Mist ③ Oil Vapor

Features & Benefits

1. VARIABLE AIR OUTPUT-

The most efficient in its range:

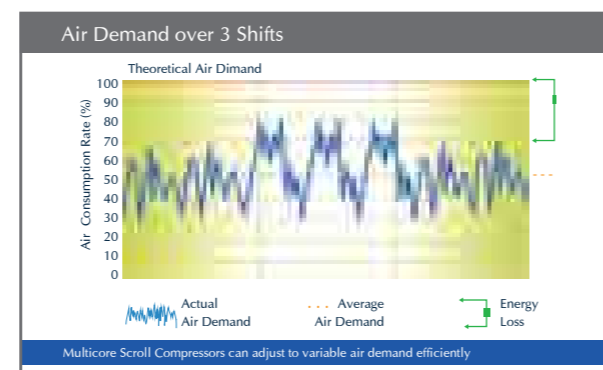
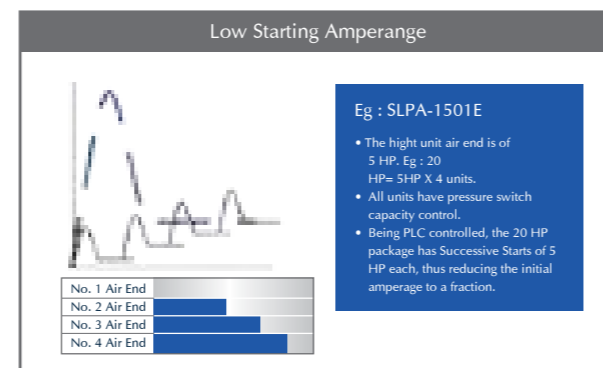
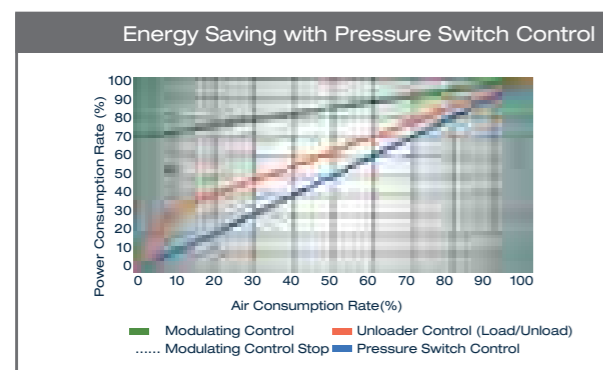

4. SILENT

Oil-free scroll mechanism has very small torque fluctuation as well as low noise and vibration.

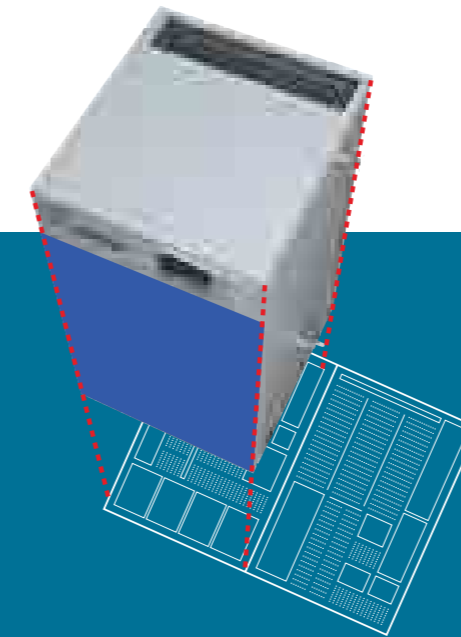
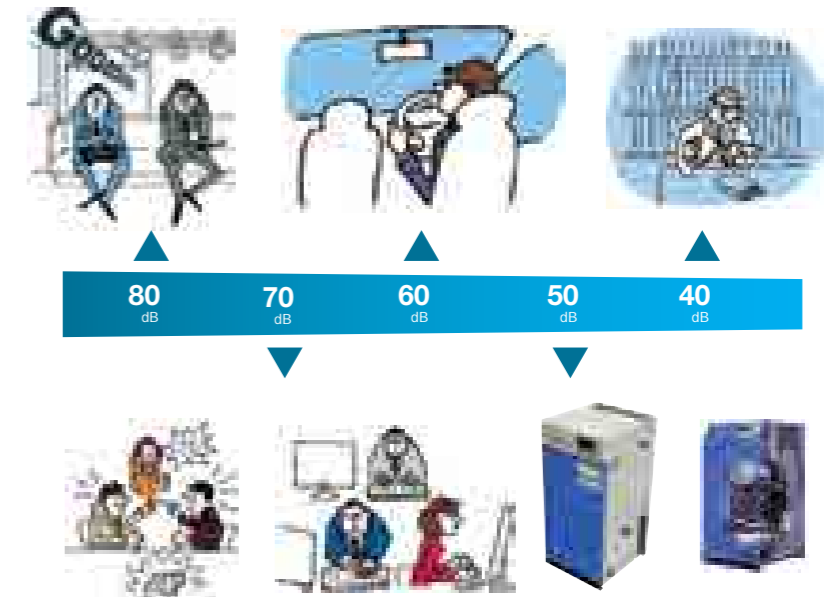

2. HYGIENE AND SAFETY

A) In oil lubricated air compressors, Oil mist in compressed Air mixes with Water and Dust to form an OIL-WATER-DUST emulsion.
 B) This emulsion accumulates in the compressed air piping may encourage Bacterial or Fungal Growth.
 C) Prolonged accumulation may encourage Bacterial or Fungal Growth.
 However, 100% oil free air compressors deliver compressed air without any risk of contamination.

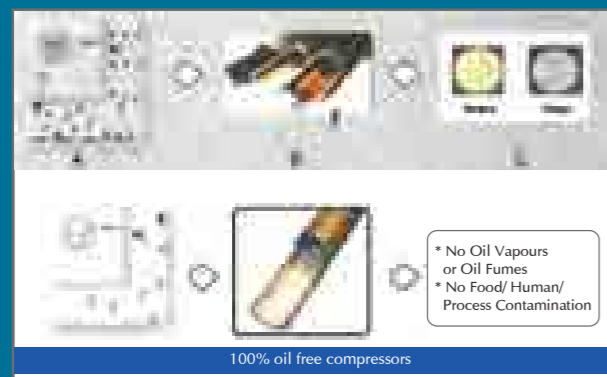

5. COMPACT

Models up to 5HP (3.7kW) have the same footprint as a newspaper page.

3. PRODUCTIVITY AND PROFITABILITY

Adhesion of Oil-Water-Dust Emulsion to high precision Bearings, Actuators, Solenoid Valves etc, may cause productivity loss due to In-process rejection, Machine Breakdown, or both. Using Oil free compressors can prevent such process breakdown & rejections.

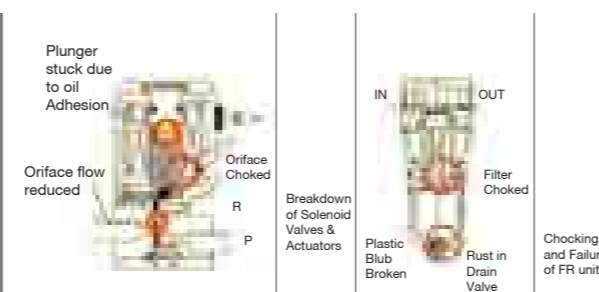

6. NO DRAIN TREATMENT NECESSARY

Drainage from oil-lubricated compressors requires proper treatment as it contains oil. Oil-free scroll compressors on the other hand are eco-friendly, their drain is clean and does not contain oil, therefore avoiding the cost of drain disposal.



the **FUTURE** of AIR



THE WORLD'S FIRST OIL-FREE SCROLL COMPRESSOR

THE WORLD'S FIRST OIL-FREE SCROLL COMPRESSOR

Applications



PRINTING MACHINE



FOOD INDUSTRIES



SEMICONDUCTOR DEVELOPMENT



LARGE SCALE PAINTING



DIAMOND INDUSTRY



HYBRID TRAIN



MEDICAL OPERATION



DENTAL CLINICS



LABORATORIES

Technical Specifications

MODEL	POWER		CONTROL SYSTEM	CONTROL PRESSURE	FREE AIR DELIVERY		AIR RECEIVER CAPACITY	OUTER DIMENSIONS	WEIGHT	NOISE LEVEL (1.5M FROM FRONT)
	KW	HP		Bar	LPM	CFM	Liters	(W x L x H) mm	Kg	dB(A)
SLPA-07EC*	0.75	1	Automatic start-stop	6~8	74	2.62	5	355 x 590 x 690	50	45
SLPM-151EE	1.5	2		8~10	130	4.60	20	453 x 507 x 955	90	46
SLPM-221EE	2.2	3		8~10	215	7.60	20		100	50
SLPM-371EE	3.7	5		8~10	345	12.20	35	544 x 622 x 1123	145	50
SLPA-551E	5.9	7.5		8~10	560	19.80	NA	650 x 955 x 1195	245	52
SLPA-751E	7.5	10		8~10	690	24.40			265	53
SLPA-1101E	11	15		8~10	1035	36.60			330	56
SLPA-1501E	15	20		8~10	1380	48.80			425	58
SLPA-2201C	22	30		8~10	2070	73.10	1400 x 1140 x 1640		900	59
SLPA-3001C	30	40		8~10	2760	97.50			1050	60

* 1hp Model is supplied for single phase, 230V~50Hz



Active & NewEST

Technology

UNIQUENESS OF SCROLL

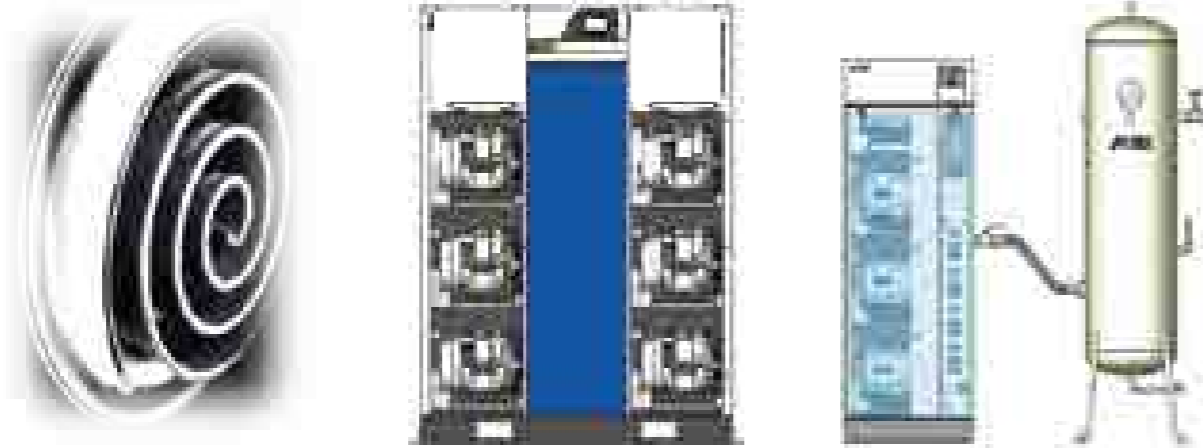

WHY ANEST IWATA?

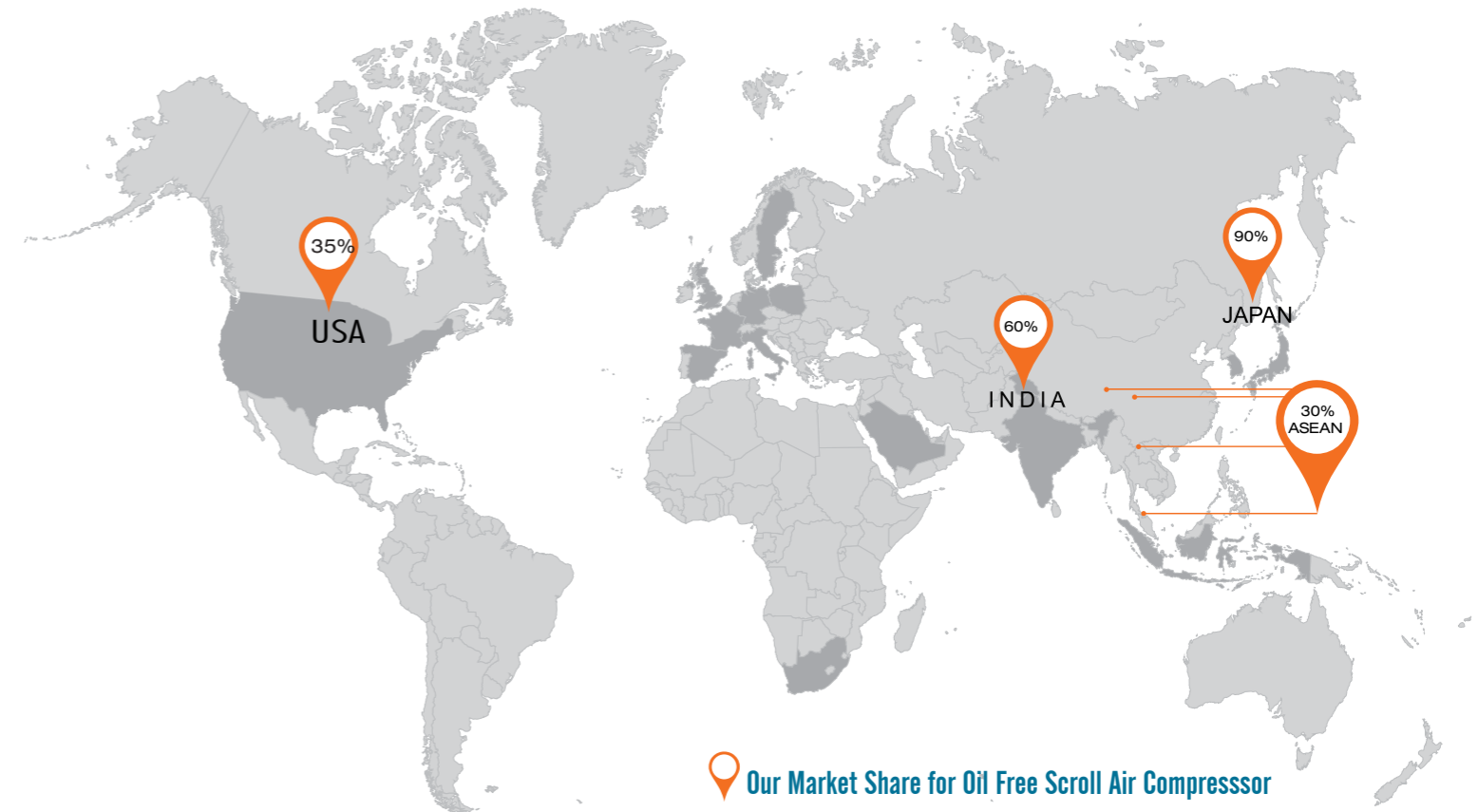

APPLICATIONS	CRITICAL REQUIREMENTS			ADVANCED FEATURES		
	No Human/Product Contamination (100% Oil Free Air)	No Oil Related Breakdown	Low Noise & Vibration	No Oil Related Rejections	Energy Efficient (Low Pressure Drop)	Energy Efficient (Variable Output)
CNC Machines with Pneumatic Operations		•			•	•
Instrumentation and R&D Analysers		•	•			
Colour Sorting	•	•		•	•	•
Semiconductor Manufacturing		•	•	•	•	
Air Bearings		•	•		•	
Food Processing	•	•		•	•	•
Beverage Processing	•	•		•	•	•
Garment Manufacturing		•		•	•	•
Glass Coating						•
Digital & Offset Printing		•		•	•	•
Hospitals	•	•	•		•	•
Dental Clinics	•		•	•	•	
Laboratories	•		•		•	
Nitrogen Generators		•			•	•
Paper Manufacturing		•		•	•	•
Pharmaceuticals Manufacturing	•	•			•	•
Premium Spray Painting	•			•		•
Cosmetics Manufacturing	•	•		•	•	•
Rubber & Leather Processing		•		•	•	•
Vacuum Metalising		•		•	•	•

The credit for pioneering the Scroll Technology goes to Anest Iwata Corporation, Japan. As a joint venture between Anest Iwata Corporation and Samvardhana Motherson, India, we, at AIM feel obliged for providing the solutions with "Japanese Ingenuity, Indian Diligence", resembling the solutions are provided as per Japanese highest quality standards while manufacturing in India.

- In 1991, AIJ (Anest Iwata, Japan) has introduced the Oil Free Scroll technology to the world.
- Our technology has been appreciated and proven globally over the years.
- We have the largest market share globally for Oil Free Scroll Air Compressors in each applications/segments.
- We are the only one having manufacturing facilities for Scroll Compressor in India resulting in quicker deliveries to our valued customers.
- Our Oil Free Scroll Air Compressor is a Class Zero certified product, most ideal for critical applications.
- The world's most Smart Compressor also has an unique feature of servicable airends, making it distinct from others with added benefit of compactness & trouble free operations.
- Anest Iwata is the only Oil Free Scroll Compressor manufacturer with strong setup for aftersales support on PAN India level including quick availability of spares, trained manpower and maintenance tools & Kits.
- With more than 60% market share in India for delivering 100% oil free air in our segment, one can assume the quality of our products and the leadership which keeps us and our valued customers miles and years ahead!

Always Ahead

With **ANEST IWATA!**



Oil Free Scroll Compressors

The Air of Trust

**CLASS ZERO
OILFREE**

Oilfree Compressor
ScrollAir
since 1991